



THUNDER TE19 2.0

Thermal Image Scope

HIKMICRO THUNDER TE19 2.0 Thermal Image Scope has a 256 × 192 thermal detector and a 1024 × 768 OLED display, which provides clear images under harsh environment conditions like darkness, fog, smoke, dust, rain, snow, wood, camouflage, etc. With an extended operation time, the scope is mainly applied to scenarios such as hiking, hunting, searching and rescuing.

Key Features

- 256 × 192 resolution with 12 μm sensor
- 1024 × 768 resolution 0.39-inch OLED display
- Supports image brightness and tone adjustment
- Up to 10 hours of continuous operation
- Replaceable and rechargeable Li-ion battery
- Supports audio and recoil-activated recording
- High shock resistance up to 1000 g/0.4 ms

Specification

THERMAL MODULE	
IMAGE SENSOR	Uncooled Focal Plane Arrays
MAX. RESOLUTION	256 × 192
FRAME RATE	50 Hz
PIXEL INTERVAL	12 μm
NETD	less than 35 mK (25°C, F# = 1.0)
LENS (FOCAL LENGTH)	19 mm
FOCUS KNOB	No
DETECTION RANGE	1000 m
MIN. FOCUSING DISTANCE	0.5 m
APERTURE	F1.0
MAGNIFICATION	2.47 ×
FIELD OF VIEW(H × V), DEGREES/M @100 M	9.24° × 6.94°/16.17 m × 12.13 m
IMAGE DISPLAY	
DISPLAY	1024 × 768, 0.39 inch, OLED
PALETTES	Black Hot, White Hot, Red Hot, Fusion
FFC (FLAT FIELD CORRECTION) MODE	Auto, Manual, External Correction
EXIT PUPIL	6 mm
EYE RELIEF	45 mm
DIOPTER (RANGE)	-5 D to 5 D
BRIGHTNESS ADJUSTMENT	Yes
TONE ADJUSTMENT	Cold, Warm
SYSTEM	
RECORD VIDEO	On-board video recording
CAPTURE SNAPSHOT	Yes
DIGITAL ZOOM	1x, 2x, 4x, 8x
STANDBY MODE	Yes
STORAGE	Built-in EMMC (16 GB)
PIP	Yes
DPC	Yes

HOTSPOT	Yes
HOT TRACK	Yes
DISTANCE MEASUREMENT	Yes
RECOIL-ACTIVATION RECORDING	Yes
AUDIO RECORDING	Yes
MAX. RECOIL	1000 g/0.4 ms
POWER SUPPLY	
BATTERY TYPE	Replaceable and Rechargeable Li-ion Battery
BATTERY OPERATING TIME	≥ 10 h (25°C, with hotspot off)
TYPE-C POWER SUPPLY	5 VDC, 2 A Supports external power supply
GENERAL	
PROTECTION LEVEL	IP67
DIMENSION	218.7 mm × 67.14 mm × 68.04 mm
WEIGHT	476 g without battery
WORKING TEMPERATURE	-30°C to +55°C (-22°F to 131°F)

Available Model

HM-TR52-19S1G/W-TE19 2.0

Dimension

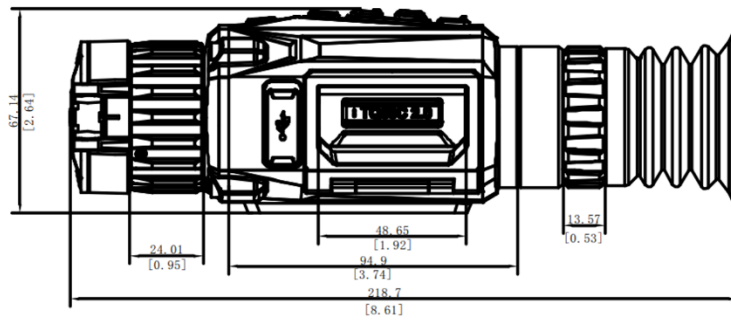
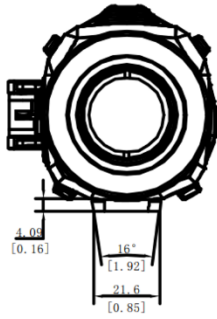
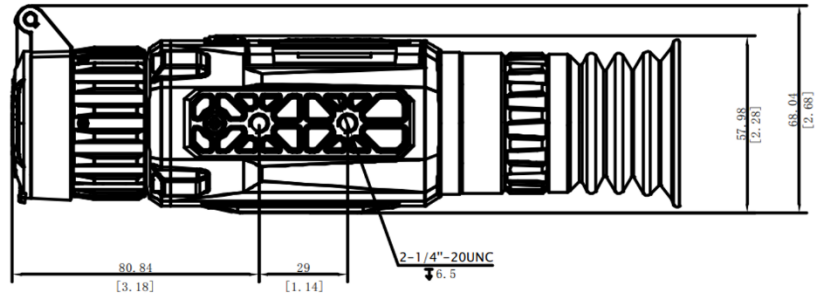

Unit:mm[Inch]

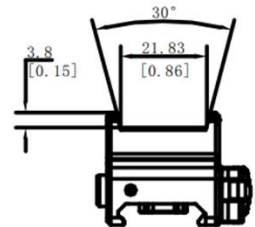
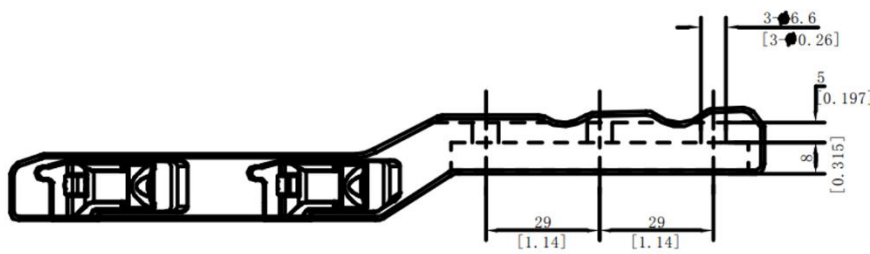

Unit: mm

Accessories

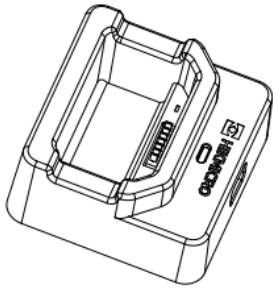

Battery Charger (x1)

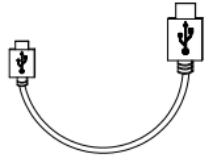

Type-C Cable (x1)

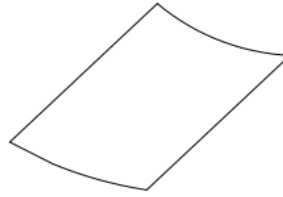

Lint-free Cloth (x1)

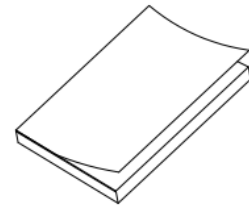

Quick Start Guide (x1)

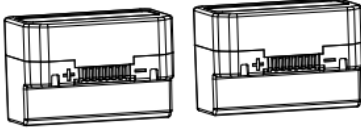

Battery (x2)



Bag (x1)

COMPLIANCE NOTICE: The thermal series products might be subject to export controls in various countries or regions, including without limitation, the United States, European Union, United Kingdom and/or other member countries of the Wassenaar Arrangement. Please consult your professional legal or compliance expert or local government authorities for any necessary export license requirements if you intend to transfer, export, re-export the thermal series products between different countries.



HIKMICRO SIGHT



HIKMICRO Outdoor hikmicro_outdoor HIKMICRO Outdoor HIKMICRO info@hikmicrotech.com <http://hikmicrotech.com/en>

Room 313, Unit B, Building 2, 399 Danfeng Road, Xixing Subdistrict, Binjiang District, Hangzhou, Zhejiang
@hangzhou microimage software co.,Ltd .2020 | data subject to change without notice!