

## FT31 Firefighting Thermal Camera



The HIKMICRO FT31 is a high-performance firefighting thermal camera designed for firefighters to observe in total darkness and smoke, helping to save lives, protect property, and keep firefighters safe. Features like object details enhancement, easy-to-navigate buttons and a working temperature range of up to 260°C(500°F) help you work effortlessly in harsh environments. 8 color palettes for you to choose from satisfy most application scenarios.

### Key Features

- Thermal resolution: 384 x 288 (110,592 pixels)
- NETD : < 35 mK (@ 25°C, F#=1.0)
- Start up time: 5 second (with IR image), 10 second (with OSD)
- Support object details enhancement
- Temperature measurement range : -20°C to 1200°C (-4°F to 2192°F)
- Measurement presets: Center spot, Hot spot, Cold spot
- 60 Hz image frequency
- 4.3" LCD screen display

## ▪ Specification

Infrared Image	
IR Resolution	384 x 288 (110,592 pixels)
NETD	< 35 mK (@ 25°C, F#=1.0)
Image Frequency	60 Hz
Detector Pitch	17 µm
Spectral Range	7.5 to 14 µm
Focal Length	7 mm
F-number	F1.6
Field of View (FOV)	54.1°×40.2°
Spatial Resolution (IFOV)	2.42 mrad
Min. Focus Distance	1 m (3.28 ft)
Focus Mode	Focus Free
Image Display	
Display	800 × 480 Resolution, 4.3" LCD Screen
Digital Zoom	1x, 2x, 4x
Color Palettes	Basic, Black Hot, White Hot, Fire Detection, Rescue, Hot Area, Cold Area, Building
Image Modes	Thermal
Measurement and Analysis	
Object Temperature Range	-20°C to 1200°C (-4°F to 2192°F)
Accuracy	Max. (± 2°C/3.6°F, ± 2%), for ambient temperature -20°C to 50°C (-4°F to 122°F) and object temperature above 0°C (32°F)
Measurement Tools	Center Spot, Hot Spot, Cold Spot
Data Storage and Communication	
Storage Media	Built-in 32 GB flash memory
Image Storage Capacity	Approx. 100,000 Images
General	
USB Interface	USB Type-C
Battery Type	Interchangeable and rechargeable Li-ion battery
Battery Operating Time	Approx. 6 hours
Battery Charging Time	Approx. 3 hours fully charged
Protection Level	IP67, IEC 60529
Drop Test Height	2 m (6.56 ft), IEC 60068-2-31
Safety	IEC 61010-1
EMC	EN 301 489-1, EN 301 489-17, EN IEC 61000-6-2, EN IEC 61000-6-3
Vibration	2g IEC 60068-2-6
Shock	25 g, IEC 60068-2-27
Working Temperature Range	-20°C to 50°C (-4°F to 122°F) 80°C(176°F) , 40min 150°C(302°F) , 15min 260°C(500°F) , 7min

Relative Humidity	< 95% non-condensing
Storage Temperature Range	-20°C to 60°C (-4°F to 140°F)
Weight	Approx. 1022g (2.25 lb)
Dimension	132.7×276.3×114.6 mm (5.2 × 10.9 × 4.5 in)
Tripod Mounting	UNC ¼"-20

## ▪ Available Model

HM-TF23-7QF-FT31

## ▪ Dimension

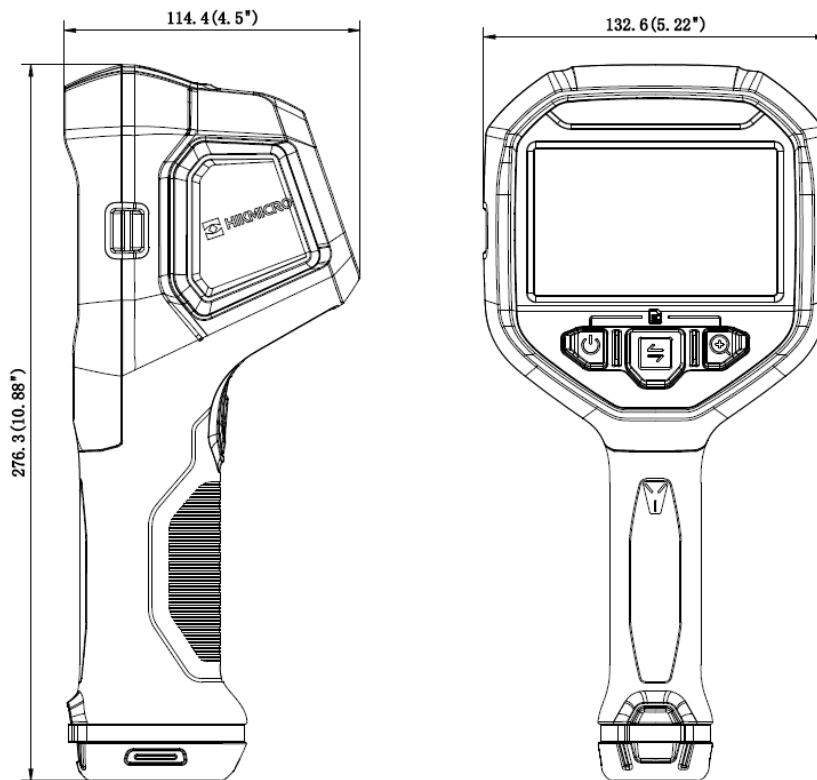

Unit:mm (Inch)

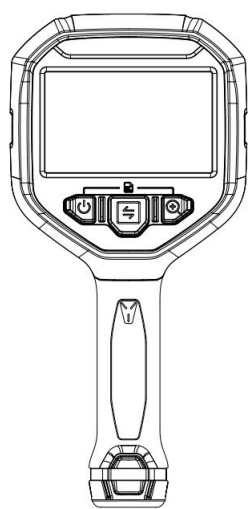

Camera (x1)

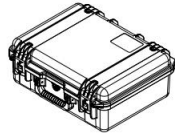

Carrying Case(x1)

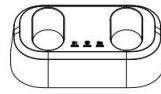

Charging Base(x1)



Battery(x1)



Quick Start Guide(x1)

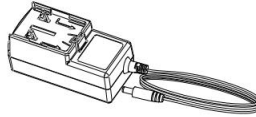

Power Adapter (x1)

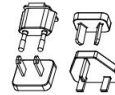

Adapter (x4)



USB Cable (x1)



Neck Strap(x1)





Retractable Lanyard(x1)



Lanyard(x1)

**COMPLIANCE NOTICE:** The thermal series products might be subject to export controls in various countries or regions, including without limitation, the United States, European Union, United Kingdom and/or other member countries of the Wassenaar Arrangement. Please consult your professional legal or compliance expert or local government authorities for any necessary export license requirements if you intend to transfer, export, re-export the thermal series products between different countries.



 HIKMICRO Thermography  hikmicro\_thermography  HIKMICRO Thermography  HIKMICRO  info@hikmicrotech.com  <http://hikmicrotech.com/en>

© 2023 Hangzhou HIKMICRO Sensing Technology Co., Ltd. All Rights Reserved.  
Data subject to change without notice!