



# Handheld Thermography Camera

M Series User Manual



Contact Us

## Legal Information

©2023 Hangzhou Microimage Software Co., Ltd. All rights reserved.

### About this Manual

The Manual includes instructions for using and managing the Product. Pictures, charts, images and all other information hereinafter are for description and explanation only. The information contained in the Manual is subject to change, without notice, due to firmware updates or other reasons. Please find the latest version of this Manual at the HIKMICRO website ( <http://www.hikmicrotech.com> ).

Please use this Manual with the guidance and assistance of professionals trained in supporting the Product.

### Trademarks

 **HIKMICRO** and other HIKMICRO's trademarks and logos are the properties of HIKMICRO in various jurisdictions.

Other trademarks and logos mentioned are the properties of their respective owners.

### Disclaimer

TO THE MAXIMUM EXTENT PERMITTED BY APPLICABLE LAW, THIS MANUAL AND THE PRODUCT DESCRIBED, WITH ITS HARDWARE, SOFTWARE AND FIRMWARE, ARE PROVIDED "AS IS" AND "WITH ALL FAULTS AND ERRORS". HIKMICRO MAKES NO WARRANTIES, EXPRESS OR IMPLIED, INCLUDING WITHOUT LIMITATION, MERCHANTABILITY, SATISFACTORY QUALITY, OR FITNESS FOR A PARTICULAR PURPOSE. THE USE OF THE PRODUCT BY YOU IS AT YOUR OWN RISK. IN NO EVENT WILL HIKMICRO BE LIABLE TO YOU FOR ANY SPECIAL, CONSEQUENTIAL, INCIDENTAL, OR INDIRECT DAMAGES, INCLUDING, AMONG OTHERS, DAMAGES FOR LOSS OF BUSINESS PROFITS, BUSINESS INTERRUPTION, OR LOSS OF DATA, CORRUPTION OF SYSTEMS, OR LOSS OF DOCUMENTATION, WHETHER BASED ON BREACH OF CONTRACT, TORT (INCLUDING NEGLIGENCE), PRODUCT LIABILITY, OR OTHERWISE, IN CONNECTION WITH THE USE OF THE PRODUCT, EVEN IF HIKMICRO HAS BEEN ADVISED OF THE POSSIBILITY OF SUCH DAMAGES OR LOSS.

YOU ACKNOWLEDGE THAT THE NATURE OF THE INTERNET PROVIDES FOR INHERENT SECURITY RISKS, AND HIKMICRO SHALL NOT TAKE ANY RESPONSIBILITIES FOR ABNORMAL OPERATION, PRIVACY LEAKAGE OR OTHER DAMAGES RESULTING FROM CYBER-ATTACK, HACKER ATTACK, VIRUS INFECTION, OR OTHER INTERNET SECURITY RISKS; HOWEVER, HIKMICRO WILL PROVIDE TIMELY TECHNICAL SUPPORT IF REQUIRED.

YOU AGREE TO USE THIS PRODUCT IN COMPLIANCE WITH ALL APPLICABLE LAWS, AND YOU ARE SOLELY RESPONSIBLE FOR ENSURING THAT YOUR USE CONFORMS TO THE APPLICABLE LAW. ESPECIALLY, YOU ARE RESPONSIBLE, FOR USING THIS PRODUCT IN A MANNER THAT DOES NOT INFRINGE ON THE RIGHTS OF THIRD PARTIES, INCLUDING WITHOUT LIMITATION, RIGHTS OF PUBLICITY, INTELLECTUAL PROPERTY RIGHTS, OR DATA PROTECTION AND OTHER PRIVACY RIGHTS. YOU SHALL NOT USE THIS PRODUCT FOR ANY PROHIBITED END-USES, INCLUDING THE

# Handheld Thermography Camera M Series User Manual

---

DEVELOPMENT OR PRODUCTION OF WEAPONS OF MASS DESTRUCTION, THE DEVELOPMENT OR PRODUCTION OF CHEMICAL OR BIOLOGICAL WEAPONS, ANY ACTIVITIES IN THE CONTEXT RELATED TO ANY NUCLEAR EXPLOSIVE OR UNSAFE NUCLEAR FUEL-CYCLE, OR IN SUPPORT OF HUMAN RIGHTS ABUSES.

IN THE EVENT OF ANY CONFLICTS BETWEEN THIS MANUAL AND THE APPLICABLE LAW, THE LATTER PREVAILS.

## Regulatory Information

---

 **Note**

These clauses apply only to the products bearing the corresponding mark or information.

---

### FCC Compliance Statement

Please take attention that changes or modification not expressly approved by the party responsible for compliance could void the user's authority to operate the equipment. This device complies with Part 15 of the FCC Rules. Operation is subject to the following two conditions:

- (1) This device may not cause harmful interference, and
- (2) This device must accept any interference received, including interference that may cause undesired operation.

Note: Due to the device size limit, the above statement may not be disclaimed on the device. This equipment complies with FCC radiation exposure limits set forth for an uncontrolled environment.

Note: This product has been tested and found to comply with the limits for a Class B digital device, pursuant to Part 15 of the FCC Rules. These limits are designed to provide reasonable protection against harmful interference in a residential installation. This product generates, uses, and can radiate radio frequency energy and, if not installed and used in accordance with the instructions, may cause harmful interference to radio communications. However, there is no guarantee that interference will not occur in a particular installation. If this product does cause harmful interference to radio or television reception, which can be determined by turning the equipment off and on, the user is encouraged to try to correct the interference by one or more of the following measures:

- Reorient or relocate the receiving antenna.
- Increase the separation between the equipment and receiver.
- Connect the equipment into an outlet on a circuit different from that to which the receiver is connected.
- Consult the dealer or an experienced radio/TV technician for help.

### EU/UK Conformity Statement



This product and - if applicable - the supplied accessories too are marked with "CE" and comply therefore with the applicable harmonized European standards listed

under the EMC Directive 2014/30/EU, RE Directive 2014/53/EU, the RoHS Directive 2011/65/EU



This product and - if applicable - the supplied accessories too are marked with "UKCA" and comply therefore with the following directives: Radio Equipment Regulations 2017, Electromagnetic Compatibility Regulations 2016, Electrical Equipment (Safety) Regulations 2016, the Restriction of the Use of Certain Hazardous Substances in Electrical and Electronic Equipment Regulations 2012.

## Frequency Bands and Power (for CE/UKCA)

The frequency bands and transmitting power (radiated and/or conducted) nominal limits applicable to the following radio equipment are as follows:

Equipment Model	Frequency Band and Power
M30 Series*	Wi-Fi 2.4 GHz (2.4 GHz to 2.4835 GHz): 20 dBm Wi-Fi 2.4 GHz (2.4 GHz to 2.4835 GHz): 20 dBm; Wi-Fi 5 GHz (5.15 GHz to 5.25 GHz): 23 dBm; Wi-Fi 5 GHz (5.25 GHz to 5.35 GHz): 23 dBm; Wi-Fi 5 GHz (5.47 GHz to 5.725GHz): 23 dBm; Wi-Fi 5 GHz (5.725 GHz to 5.85 GHz): 14 dBm
M10 Series	Wi-Fi 2.4 GHz (2.4 GHz to 2.4835 GHz): 20 dBm

\*For M30 Series, please pay attention to the following notes when the device is operating in 5 GHz: According to Article 10 (10) of Directive 2014/53/EU, when operating in the 5150 to 5350 MHz frequency range, this device is restricted to indoor use in: Austria (AT), Belgium (BE), Bulgaria (BG), Croatia (HR), Cyprus (CY), the Czech Republic (CZ), Denmark (DK), Estonia (EE), Finland (FI), France (FR), Germany (DE), Greece (EL), Hungary (HU), Iceland (IS), Ireland (IE), Italy (IT), Latvia (LV), Liechtenstein (LI), Lithuania (LT), Luxembourg (LU), Malta (MT), Netherlands (NL), Northern Ireland (UK(NI)), Norway (NO), Poland (PL), Portugal (PT), Romania (RO), Slovakia (SK), Slovenia (SI), Spain (ES), Sweden (SE), Switzerland (CH), and Turkey (TR).

In accordance with the Radio Equipment Regulations 2017 in the UK, the device working in the 5150 to 5350 MHz frequency range is restricted to indoor use in the United Kingdom.

Use the power adapter provided by a qualified manufacturer. Refer to the product specification for detailed power requirements.

Use the battery provided by a qualified manufacturer. Refer to the product specification for detailed battery requirements.



2012/19/EU (WEEE directive): Products marked with this symbol cannot be disposed of as unsorted municipal waste in the European Union. For proper recycling, return this product to your local supplier upon the purchase of equivalent new equipment, or dispose of it at designated collection points. For more information see: [www.recyclethis.info](http://www.recyclethis.info)



According to the Waste Electrical and Electronic Equipment Regulations 2013: Products marked with this symbol cannot be disposed of as unsorted municipal waste in the United Kingdom. For proper recycling, return this product to your local supplier upon the purchase of equivalent new equipment, or dispose of it at designated collection points. For more information see: [www.recyclethis.info](http://www.recyclethis.info).



2006/66/EC (battery directive): This product contains a battery that cannot be disposed of as unsorted municipal waste in the European Union. See the product documentation for specific battery information. The battery is marked with this symbol, which may include lettering to indicate cadmium (Cd), lead (Pb), or mercury (Hg). For proper recycling, return the battery to your supplier or to a designated collection point. For more information see: [www.recyclethis.info](http://www.recyclethis.info)

According to the Batteries and Accumulators (Placing on the Market) Regulations 2008 and the Waste Batteries and Accumulators Regulations 2009: This product contains a battery that cannot be disposed of as unsorted municipal waste in the United Kingdom. See the product documentation for specific battery information. The battery is marked with this symbol, which may include lettering to indicate cadmium (Cd), lead (Pb), or mercury (Hg). For proper recycling, return the battery to your supplier or to a designated collection point. For more information see: [www.recyclethis.info](http://www.recyclethis.info).

## Industry Canada ICES-003 Compliance

This device meets the CAN ICES-003(B)/NMB-003(B) standards requirements.

This device complies with Industry Canada licence-exempt RSS standard(s). Operation is subject to the following two conditions:

- (1) this device may not cause interference, and
- (2) this device must accept any interference, including interference that may cause undesired operation of the device.

This equipment complies with IC RSS-102 radiation exposure limits set forth for an uncontrolled environment.

Le présent appareil est conforme aux CNR d'Industrie Canada applicables aux appareils radioexempts de licence. L'exploitation est autorisée aux deux conditions suivantes :

- (1) l'appareil ne doit pas produire de brouillage, et

- (2) l'utilisateur de l'appareil doit accepter tout brouillage radioélectrique subi, même si le brouillage est susceptible d'en compromettre le fonctionnement.

\*For M30 Series, please pay attention to the following notes when the device is operating in 5 GHz:

- (i) The device for operation in the band 5150-5250 MHz is only for indoor use to reduce the potential for harmful interference to co-channel mobile satellite systems;
- (ii) The maximum antenna gain permitted for devices in the bands 5250-5350 MHz and 5470-5725 MHz shall comply with the e.i.r.p. limit; and
- (iii) The maximum antenna gain permitted for devices in the band 5725-5825 MHz shall comply with the e.i.r.p. limits specified for point-to-point and non point-to-point operation as appropriate.

ce matériel est conforme aux limites de dose d'exposition aux rayonnements, CNR-102 énoncée dans un autre environnement.



- (i) Les dispositifs fonctionnant dans la bande 5150-5250 MHz sont réservés uniquement pour une utilisation à l'intérieur afin de réduire les risques de brouillage préjudiciable aux systèmes de satellites mobiles utilisant les mêmes canaux.
- (ii) Le gain d'antenne maximal autorisé pour les appareils dans les bandes 5250-5350 MHz et 5470-5725 MHz doivent respecter le pire limiter; et
- (iii) Le gain d'antenne maximal autorisé pour les appareils dans la bande 5725-5825 MHz doivent respecter le pire limites spécifiées pour le point-à-point et l'exploitation non point à point, le cas échéant.

## KC

B급 기기: 이 기기는 가정용(B급) 전자파적합기기으로써 주로 가정에서 사용하는 것을 목적으로 하며, 모든 지역에서 사용할 수 있습니다.

## Symbol Conventions

The symbols that may be found in this document are defined as follows.

Symbol	Description
 <b>Danger</b>	Indicates a hazardous situation which, if not avoided, will or could result in death or serious injury.
 <b>Caution</b>	Indicates a potentially hazardous situation which, if not avoided, could result in equipment damage, data loss, performance degradation, or unexpected results.
 <b>Note</b>	Provides additional information to emphasize or supplement important points of the main text.



## Safety Instruction

These instructions are intended to ensure that user can use the product correctly to avoid danger or property loss.

### Laws and Regulations

- Use of the product must be in strict compliance with the local electrical safety regulations.

### Transportation

- Keep the device in original or similar packaging while transporting it.
- Keep all wrappers after unpacking them for future use. In case of any failure occurred, you need to return the device to the factory with the original wrapper. Transportation without the original wrapper may result in damage on the device and the company shall not take any responsibilities.
- DO NOT drop the product or subject it to physical shock. Keep the device away from magnetic interference.

### Power Supply

- Input voltage for device should meet the Limited Power Source (5 VDC, 700 mA) according to the IEC61010-1 standard. Please refer to technical specifications for detailed information.
- Make sure the plug is properly connected to the power socket.
- DO NOT connect multiple devices to one power adapter, to avoid over-heating or fire hazards caused by overload.

### Battery

- Improper use or replacement of the battery may result in explosion hazard. Replace with the same or equivalent type only. Dispose of used batteries in conformance with the instructions provided by the battery manufacturer.
- The built-in battery cannot be dismantled. Please contact the manufacture for repair if necessary.
- For long-term storage of the battery, make sure it is fully charged every half year to ensure the battery quality. Otherwise, damage may occur.
- When the device is powered off and the RTC battery is full, the time settings can be kept for 2 months.
- In the first use, power on the device and charge the RTC battery with the lithium battery for more than 8 hours.
- The lithium battery voltage is 3.7 V, and the battery capacity is 5000 mAh.
- The battery is certified by UL2054.

## Maintenance

- If the product does not work properly, please contact your dealer or the nearest service center. We shall not assume any responsibility for problems caused by unauthorized repair or maintenance.
- A few device components (e.g., electrolytic capacitor) require regular replacement. The average lifespan varies, so periodic checking is recommended. Contact your dealer for details.
- Wipe the device gently with a clean cloth and a small quantity of ethanol, if necessary.
- If the equipment is used in a manner not specified by the manufacturer, the protection provided by the device may be impaired.
- Please notice that the current limit of USB 3.0 PowerShare port may vary with the PC brand, which is likely to result in incompatibility issue. Therefore, it's advised to use regular USB 3.0 or USB 2.0 port if the USB device fails to be recognized by PC via USB 3.0 PowerShare port.
- We recommend you send the device back for calibration once a year, and please contact the local dealer for the information on maintenance points.

## Using Environment

- DO NOT expose the device to extremely hot, cold, dusty, corrosive, saline-alkali, or damp environments. Make sure the running environment meets the requirement of the device. The operating temperature shall be -10°C to 50°C (14°F to 122°F), and the operating humidity shall be 90% or less.
- This device can only be safely used in the region below 2000 meters above the sea level.
- Place the device in a dry and well-ventilated environment.
- DO NOT expose the device to high electromagnetic radiation or dusty environments.
- DO NOT aim the lens at the sun or any other bright light.
- When any laser equipment is in use, make sure that the device lens is not exposed to the laser beam, or it may burn out.
- The device is suitable for indoor conditions.
- The pollution degree is 2.
- Overvoltage category: 0 for Handheld Thermography Camera.
- Overvoltage category: II for power adapter.

## Technical Support

The <https://www.hikmicrotech.com/en/contact-us/> portal will help you as a HIKMICRO customer to get the most out of your HIKMICRO products. The portal gives you access to our support team, software and documentation, service contacts, etc.

## Emergency

- If smoke, odor, or noise arises from the device, immediately turn off the power, unplug the power cable, and contact the service center.

## Laser Light Supplement Warning



Warning: The laser radiation emitted from the device can cause eye injuries, burning of skin or inflammable substances. Prevent eyes from direct laser. Before enabling the Light Supplement function, make sure no human or inflammable substances are in front of the laser lens. The wave length is 650 nm, and the power is less than 1 mW. The laser meets the IEC60825-1:2014 standard. Laser maintenance: It is not necessary to maintain the laser regularly. If the laser does not work, the laser assembly needs to be replaced in the factory under warranty. Keep the device power off when replacing laser assembly. Caution-Use of controls or adjustments or performance of procedures other than those specified herein may result in hazardous radiation exposure.

## Manufacture Address

Room 313, Unit B, Building 2, 399 Danfeng Road, Xixing Subdistrict, Binjiang District, Hangzhou, Zhejiang 310052, China

Hangzhou Microimage Software Co., Ltd

COMPLIANCE NOTICE: The thermal series products might be subject to export controls in various countries or regions, including without limitation, the United States, European Union, United Kingdom and/or other member countries of the Wassenaar Arrangement. Please consult your professional legal or compliance expert or local government authorities for any necessary export license requirements if you intend to transfer, export, re-export the thermal series products between different countries.

# Contents

<b>Chapter 1 Overview .....</b>	<b>1</b>
1.1 Device Description .....	1
1.2 Main Function .....	1
1.3 Appearance .....	2
<b>Chapter 2 Preparation .....</b>	<b>5</b>
2.1 Charge Device .....	5
2.1.1 Charge Device via Charging Base .....	5
2.1.2 Charge Device via Cable Interface .....	6
2.2 Power On/Off .....	6
2.2.1 Set Auto Power-off Duration .....	7
2.3 Sleep and Wake .....	7
2.4 Operation Method .....	7
2.5 Menu Description .....	8
<b>Chapter 3 Display Settings .....</b>	<b>12</b>
3.1 Focus Lens .....	12
3.2 Set Screen Brightness .....	12
3.3 Set Display Mode .....	13
3.4 Set Palettes .....	13
3.4.1 Set Alarm Mode Palettes .....	14
3.4.2 Set Focus Mode Palettes .....	15
3.5 Adjust Display Temperature Range .....	16
3.6 Adjust Digital Zoom .....	18
3.7 Display OSD Info .....	18
<b>Chapter 4 Temperature Measurement .....</b>	<b>19</b>
4.1 Set Measurement Parameters .....	19
4.1.1 Set Unit .....	20

4.2 Set Image Measurement .....	20
4.3 Set Measurement Tool .....	21
4.3.1 Measure by Custom Spot .....	21
4.3.2 Measure by Line .....	22
4.3.3 Measure by Rectangle .....	23
4.3.4 Measure by Circle .....	24
4.4 Temperature Alarm .....	25
4.4.1 Set Alarms for Exceptional Temperatures .....	25
4.5 Clear All Measurements .....	26
<b>Chapter 5 Picture and Video .....</b>	<b>27</b>
5.1 Capture Picture .....	27
5.2 Record Video .....	29
5.3 View and Manage Local Files .....	30
5.3.1 Manage Albums .....	30
5.3.2 Manage Files .....	31
5.3.3 Edit Images .....	32
5.4 Export Files .....	33
<b>Chapter 6 Thermal View Mobile Client Connection .....</b>	<b>35</b>
6.1 Connect via Wi-Fi .....	35
6.2 Connect via Hot Spot .....	35
<b>Chapter 7 Connect Device to Wi-Fi .....</b>	<b>36</b>
<b>Chapter 8 Set Device Hotspot .....</b>	<b>37</b>
<b>Chapter 9 Pair Bluetooth Devices .....</b>	<b>38</b>
<b>Chapter 10 Cast Device Screen to PC .....</b>	<b>39</b>
<b>Chapter 11 Light Settings .....</b>	<b>40</b>
11.1 Set LED Light .....	40
11.2 Set Laser .....	40
<b>Chapter 12 Maintenance .....</b>	<b>41</b>

12.1 View Device Information .....	41
12.2 Set Date and Time .....	41
12.3 Upgrade Device .....	41
12.4 Restore Device .....	41
12.5 Initialize Memory Card .....	42
12.6 About Calibration .....	42
<b>Chapter 13 Appendix .....</b>	<b>43</b>
13.1 Common Material Emissivity Reference .....	43
13.2 FAQ .....	43
13.3 Device Command .....	44
13.4 Device Communication Matrix .....	44

# Chapter 1 Overview

## 1.1 Device Description

Thermographic Handheld Camera is a device with both visual images and thermal images. It can measure temperature, record videos, take snapshots, trigger alarms, and it can connect to client software via Wi-Fi or hotspot. The built-in high-sensitivity IR detector and high-performance sensor detects the variation of temperature and measure the real-time temperature.

The picture-in-picture technique of the camera and the fusion of visual view and thermal view, enhances the details of the images display. It supports multiple color palettes types for temperature display. It helps to find the risky part and lower your property loss, but it can not be used for human body temperature test.

The device is easy to use, and adopts ergonomic design. It is widely applied to substations, electricity prevention detection of companies, and reconnaissance survey of construction field.

## 1.2 Main Function

### Temperature Measurement

Device detects the real-time temperature, and display it on the screen.

### Storage

Device is equipped with memory module to store videos, snapshots, and important data.

### Fusion

Device can display fusion of thermal view and optical view.

### Palettes

Device supports multiple color palettes for temperature display. You can also set palettes for a specific temperature range in alarm mode palettes and focus mode palettes to make it prominent from the rest.

### Client Software Connection

- Mobile Phone: Use HIKMICRO Viewer to view live image, capture snapshots, and record videos on your phone. You can also, analyze pictures offline, generate and share a report via the app. Scan the QR codes on the cover to download the App.
- PC: Use HIKMICRO Analyzer to analyze pictures offline professionally, and generate a custom format report on your PC. Download the client software from <https://www.hikmicrotech.com/en/industrial-products/hikmicro-analyzer-software.html>

## Bluetooth

Device can be connected to headset via Bluetooth, and you can hear the voice in the recording or capture.

## Digital Zoom

Device supports digital zoom from 1.0x to 8.0x.

## LED Light

LED light supplement makes the device a torch in required scenarios.

## Laser Light

Long-distance laser light supplement.

## 1.3 Appearance

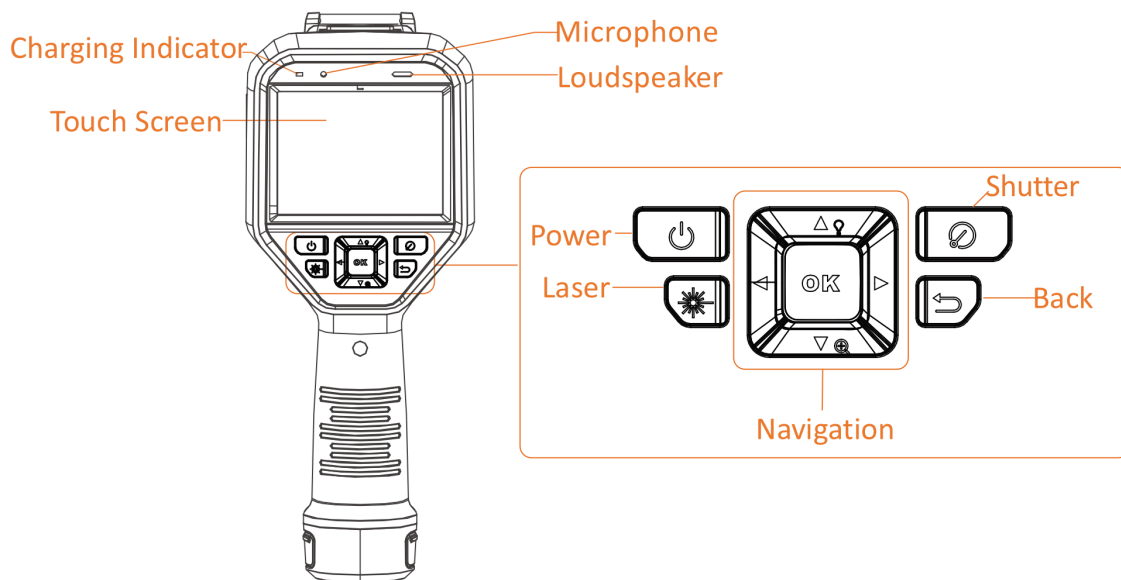
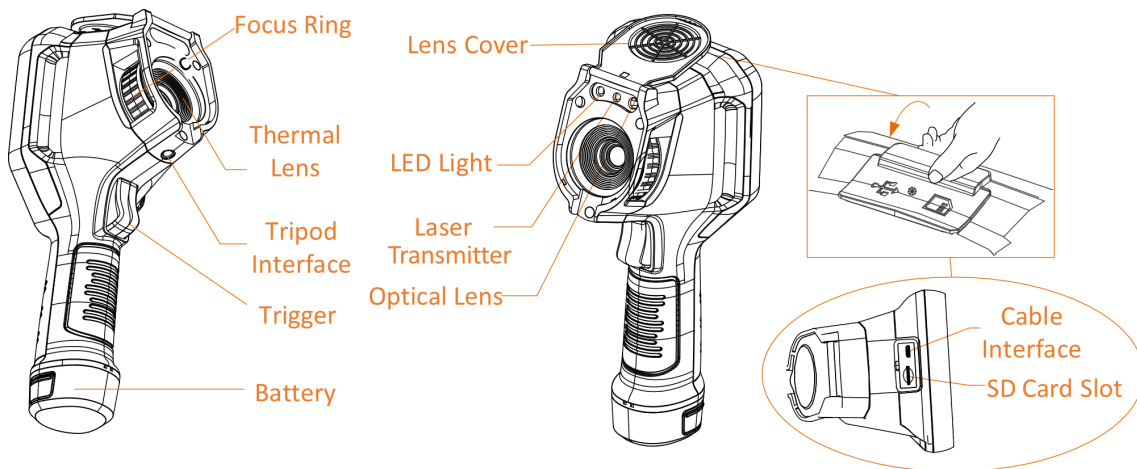

Figure 1-1 Appearance



# Handheld Thermography Camera M Series User Manual



## Note

The warning sign is inside the lens cover.

**Table 1-1 Interface Description**

Component	Function
Laser Button	Hold the button to turn on laser, and release the button to turn off laser.
Navigation Button	<p>Menu Mode:</p> <ul style="list-style-type: none"> <li>Press <math>\Delta</math>, <math>\nabla</math>, <math>\triangleright</math> and <math>\triangleleft</math> to select parameters.</li> <li>Press <math>\triangleright</math> to enter the submenu.</li> <li>Press <math>\triangleleft</math> to return to the previous menu.</li> <li>Press <math>\text{OK}</math> to confirm.</li> </ul> <p>Non-Menu Mode:</p> <ul style="list-style-type: none"> <li>Press <math>\Delta</math> to turn on/off the LED light.</li> <li>Press <math>\nabla</math> to start digital zoom.</li> </ul>
Shutter Button	Cover the lens to perform the correction.
Back Button	Exit the menu or return to previous menu.
Focus Ring	Adjust lens to make the image clear. Refer to <b><i>Focus Lens</i></b> .
Trigger	<ul style="list-style-type: none"> <li>Menu Mode: Pull the trigger to return to the live view interface.</li> <li>Non-Menu Mode: Pull the trigger to capture. Hold the trigger to record videos.</li> </ul>
Cable Interface	Charge the device or export files with supplied cable.



### **Caution**

The laser radiation emitted from the device can cause eye injuries, burning of skin or inflammable substances. Before enabling the light supplement function, make sure no human or inflammable substances are in front of the laser lens.

## Chapter 2 Preparation

### 2.1 Charge Device

---

#### Caution

The built-in cell battery that powers the real time clock (RTC) of the device may drain during longtime transportation or storage. It is recommended to recharge the RTC battery for the well-functioning of the device clock.

To fully charge the RTC battery, the following requirements should be met:

- The rechargeable lithium batteries should be installed on the device.
  - The device should keep working for more than 8 hours before shutting down.
- 

#### 2.1.1 Charge Device via Charging Base

##### Steps

---

#### Note

Please charge the device with the cable and power adapter supplied by the manufacturer (or according to the input voltage from the specifications).

---

1. Hold the device, and press both battery lock catches of the device.

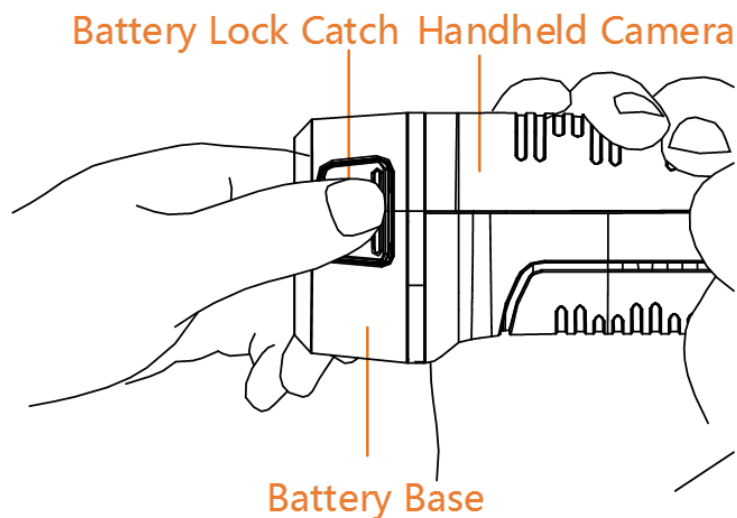

**Figure 2-1 Remove Battery**

2. Hold the lock catches, and draw the battery base to take out the battery.
  3. Insert the battery into the charging base. You can see the charging status via the pilot lamp on the charging base.
-

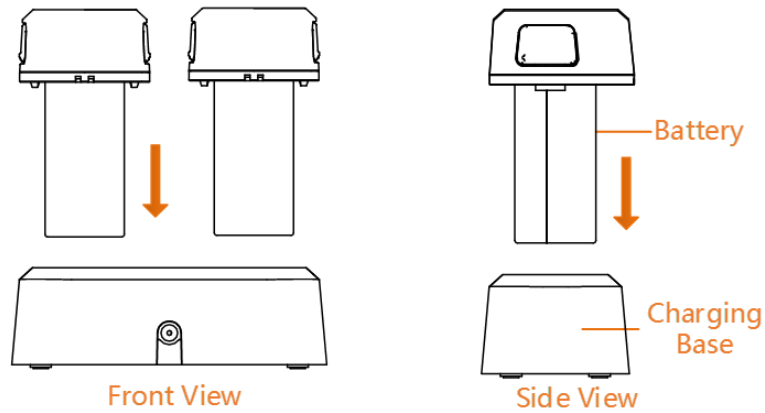

**Figure 2-2 Charge Battery**

4. When the battery is fully charged, draw the battery from the charging base.
5. Align the ribbed piece on battery with the notch of the device, and insert battery into the device.

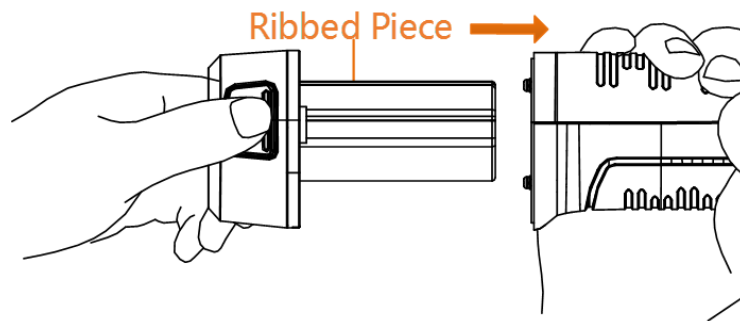

**Figure 2-3 Insert Battery**

## 2.1.2 Charge Device via Cable Interface

### Before You Start

Please make sure the battery is installed before charging.

### Steps

1. Open the top cover of the device.
2. Connect the interface and the power adaptor with Type-C or USB cable.

## 2.2 Power On/Off

## Power On

Remove the lens cover, and hold  for over three seconds to turn on the device. You can observe the target when the interface of the device is stable.



### Note

It may take at least 30 s until the device is ready for using when you power on it.

---

## Power Off

When the device is turned on, hold  for three seconds to power off the device.

### 2.2.1 Set Auto Power-off Duration

Go to **Settings** → **Device Settings** → **Auto Off** to set the automatic shutdown time for device as required.

## 2.3 Sleep and Wake

Sleep and wake function is used to save energy and increase battery time. The function is only supported by certain models of this series.

### Sleep and Wake Manually

Press  to enter sleep mode and press it again to wake the device up.

### Set Auto Sleep

In live view, press  to call the main menu. Go to **Settings** → **Device Settings** → **Auto Sleep** to set waiting time before auto sleep. When there is no button pressing or screen tapping operation on device for more than the set waiting time, device enters sleep mode automatically.

Press  to wake the device up.

### Device Sleep, Scheduled Capture and Video Recording

When the device is recording a video clip or on scheduled capturing, auto sleep will not be triggered. However, press  will stop the video recording or scheduled capture and force the device into sleep mode.

## 2.4 Operation Method

The device supports both touch-screen control and button control.

### Touch-screen control

Tap on the screen to set parameters and configurations.

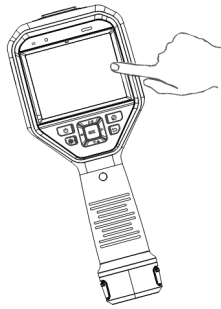

**Figure 2-4 Touch-screen Control**

## **Button control**

Press the navigation buttons to set parameters and configurations.

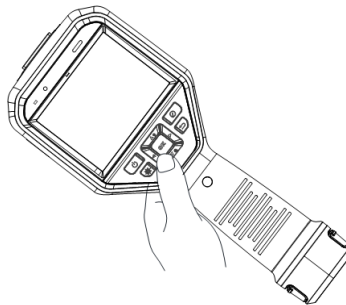

**Figure 2-5 Button Control**

- Press  $\triangle$ ,  $\nabla$ ,  $\triangleleft$ , and  $\triangleright$  to select parameters.
- Press  $\triangleright$  to enter the submenu.
- Press  $\triangleleft$  to return to the previous menu.
- Press  $\text{OK}$  to confirm.



## **2.5 Menu Description**

### **Live View Interface**

Device screen display the live view of thermal camera after starting-up.



**Table 2-1 Live View Interface Description**

No.	Descriptions
1	Status bar, where device working status, such as, battery and connections, are displayed.
2	<p>Palette bar and display temperature range. The upper and lower values of the palette bar represent the max. temperature and the min. temperature of the current display temperature range.</p> <p> <b>Note</b>                      If a "~" appears before a temperature value, it means that your device is not well prepared for accurate temperature measurement. Take target temperatures when the sign disappears.</p>
3	Shows current temperature unit and target emissivity.
4	Main menu icon. Press  or tap  to call main menu.

## Main Menu

Supported operations in the main menu from left to right are settings, local file browsing and managing, display mode configuration, temperature measurement, palettes changing, and level & span.



Figure 2-6 Main Menu

### Swipe-down Menu

In live view interface, swiping on screen from upper to lower to call the swipe-down menu. With this menu, you can turn on/off device function, change display theme, and adjust screen brightness.

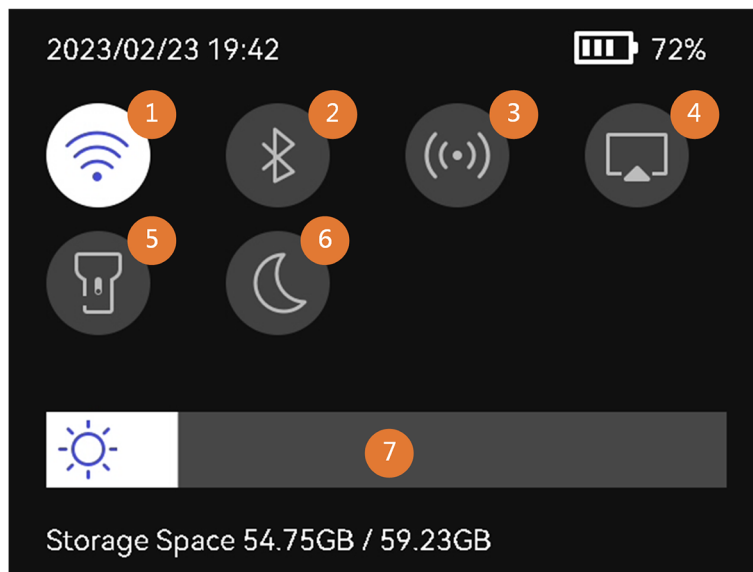

Figure 2-7 Swipe-down Menu

Table 2-2 Swipe-down Menu Description

No.	Descriptions
1	Turn on/ off Wi-Fi. For Wi-Fi configuration, see <a href="#"><i>Connect Device to Wi-Fi</i></a> for instructions.
2	Turn on/ off bluetooth. For bluetooth configuration, see <a href="#"><i>Pair Bluetooth Devices</i></a> for instructions.
3	Turn on/ off hotspot. For hotspot configuration, see <a href="#"><i>Set Device Hotspot</i></a> for instructions.
4	Turn on/ off USB cast screen. See <a href="#"><i>Cast Device Screen to PC</i></a> for instructions.
5	Turn on/ off LED light.



<b>No.</b>	<b>Descriptions</b>
6	Switch themes, day and night are supported.
7	Adjust screen brightness.

## Chapter 3 Display Settings

---

### Note

Your device will periodically perform a self-calibration to optimize image quality and measurement accuracy. In this process the image will pause briefly and you'll hear a "click" as a shutter moves in front of the detector. The self-calibration will be more frequent during start up or in very cold or hot environments. This is a normal part of operation to ensure optimum performance for your device.

---

### 3.1 Focus Lens

Adjust the lens focal length properly before you set any other configurations, or it may affect the image display and temperature accuracy.

#### Steps

1. Power on the device.
2. Aim the device lens to the appropriate scene.
3. Adjust the focus ring clockwise or anticlockwise, see figure below.

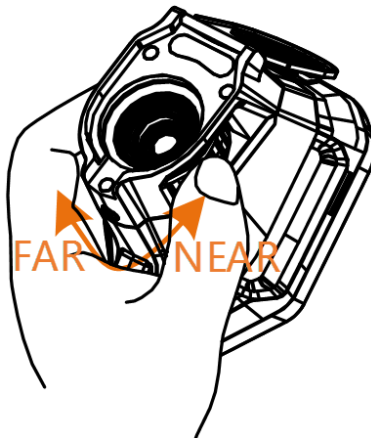

Figure 3-1 Focus Lens

### Note

DO NOT touch the lens to avoid affecting the display effect.

### 3.2 Set Screen Brightness

Call the swipe-down menu, or go to **Settings** → **Device Settings** → **Screen Brightness** . Swipe the brightness bar or press < / > to adjust the screen brightness.

## 3.3 Set Display Mode

You can set the thermal/optical view of the device. **Thermal**, **Fusion**, **PIP**, **Visual**, and **Blending** are selectable.

### Steps

1. Select  from the main menu.



In live view, tap the display mode shortcut key  on the right to switch display modes quickly.

2. Tap on the icons to select a display mode.



In **Thermal** mode, the device displays the thermal view.



In **Fusion** mode, the device displays the combined view of thermal channel and optical channel.

Press  $\triangleleft$  and  $\triangleright$  to adjust **Parallax Correction** according to the distance to the target, so as to better overlap the thermal and optical images.



In **PIP** (Picture in Picture) mode, the device displays thermal view inside the optical view.



Select **PIP**, and enter PIP setting interface.

- Adjust position: Tap the PIP view, and drag it to the target position on screen.
- Adjust size: Tap one of the PIP view corners, and drag it to adjust the size.



In **Visual** mode, the device displays the optical view.



In **Blending** mode, the device displays the mixture view of thermal and optical channels.

Press  $\triangleleft$  and  $\triangleright$  to adjust the **Optical Level**. The lower the value is, the denser the optical effect is.

3. Press  to exit.

## 3.4 Set Palettes

The palettes allow you to select the desired colors.

### Steps

1. Select  from the main menu.

2. Tap on the icons to select a palette type.

**White Hot**

The hot part is light-colored in view.

**Black Hot**

The hot part is black-colored in view.

**Rainbow**

The target displays multiple colors, it is suitable for scene without obvious temperature difference.

**Ironbow**

The target is colored as heated iron.

**Red Hot**

The hot part is red-colored in view.

**Fusion**

The hot part is yellow-colored and the cold part is purple-colored in view.

**Rain**

The hot part in the image is colored, and the else is blue.

**Blue Red**

The hot part in the image is colored red, and the else is blue.

3. Press  to exit the setting interface.

**Note**

You can also tap  in the shortcut bar in live view to change the palettes.

---





### 3.4.1 Set Alarm Mode Palettes





Alarm mode palettes allows to mark the targets of certain temperature range with a different color from the rest.

**Steps**

1. Select **Palettes** from the main menu.
2. Tap the icons to select an alarm rule type.

**Table 3-1 Icon Description**

Icon	Alarm Mode	Description
	Above Alarm	Set the alarm temperature, and the targets with the temperature higher than the set value are displayed in red.
	Below Alarm	Set the alarm temperature, and targets with the temperature lower than the set value are displayed in blue.
	Interval Alarm	Set the alarm temperature section (e.g., 90 °C to 150 °C), and targets with the temperature in the range are displayed in yellow.
	Insulation Alarm	Set the alarm temperature section (e.g., 90 °C to 120 °C), targets with the temperature out of the section (e.g., 70 °C or 125 °C) are displayed in purple or blue.

3. **Optional:** Press  and  to select between upper limit and lower limit.
4. Press  and  to adjust the rule temperature.
5. Press  to exit.



### 3.4.2 Set Focus Mode Palettes



Focus mode palettes allows to mark the targets of certain temperature range with fusion palettes and the others with white hot palettes.



#### Steps

1. Select **Palettes** from the main menu.
2. Tap the icons to select an alarm rule type.

**Table 3-2 Icon Description**

Icon	Palettes Mode	Description
	Above Focus	Set the temperature threshold, and the targets with the temperature higher than the set value are displayed with fusion palettes.
	Below Focus	Set the temperature threshold, and targets with the temperature lower than the set value are displayed with fusion palettes.
	Interval Focus	Set the temperature range (e.g., 90 °C to 150 °C), and targets in the range are displayed with fusion palettes.

**3. Optional:** Press  and  to select between upper limit and lower limit.





**4.** Press  and  to adjust the rule temperature.

**5.** Press  to exit.

### 3.5 Adjust Display Temperature Range

Set a temperature range for screen display and the palette only works for targets within the temperature range. You can adjust the temperature range.

#### Steps

- Select an adjustment mode.
  - In live view, press  to call the main menu.
  - Tap .
  - Choose **Auto**  or **Manual** .
- Adjust the display temperature range.

**Auto Adjustment** Select . The device adjusts display temperature range according to the actual targets temperature automatically.

**Manual Adjustment** There are two modes to manually adjust display temperature range. You can go to **Settings → Measurement Settings → Manual Level and Span Mode** to choose the preferred mode.

#### Level Only

You can manually adjust the maximum temperature and the minimum temperature respectively to expand or reduce the temperature range.

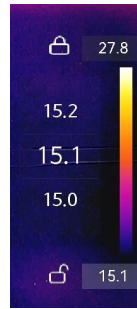

**Figure 3-2 Level Only Adjustment**

You can adjust the temperature range in this mode by the following steps:

- Tap on an interest area of the screen. A circle is displayed around the area, and the temperature range readjusts to show as many details of the area as possible, according to the selected area.
- You can press  $\triangleleft$  or  $\triangleright$ , or tap on the value on screen to lock or unlock a value. Press  $\triangleup$  or  $\triangledown$ , or scroll the adjustment wheel on the screen to fine-tune the maximum temperature and the minimum temperature respectively.
- Press  $\text{OK}$  to confirm.

### Level & Span

You can increase or decrease the individual values of both the maximum temperature and the minimum temperature while remaining the same temperature range. You can also expand or reduce the temperature range evenly.



**Figure 3-3 Level & Span Adjustment**

You can adjust the temperature range in this mode:

- a. Tap on an interest area of the screen. A circle is displayed around the area, and the temperature range readjusts to show as many details of the area as possible.
- b. Press  $\triangle$  or  $\nabla$  to increase or decrease the individual values of both maximum temperature and the minimum temperature while remaining the same temperature range.
- c. Press  $\triangleleft$  or  $\triangleright$  to expand or reduce the temperature range evenly.
- d. Press  $\text{OK}$  to confirm.

3. Press  $\text{ESC}$  to save settings and exit. You can also press  $\text{OK}$  or tap  $\text{OK}$  to save settings and exit.

## 3.6 Adjust Digital Zoom

In the live view interface, press  $\nabla$  to enter the digital zoom setting interface.

- Hold  $\triangleleft$  or  $\triangleright$  to zoom in or zoom out continuously.

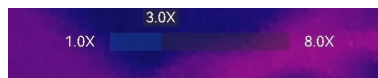

**Figure 3-4 Adjust Zooming Ratio Continuously**

- Press  $\triangleleft$  or  $\triangleright$  to fine-tune the zooming ratio.



**Figure 3-5 Fine-Tune Zooming Ratio**

- Tap the zooming ratio slider, and drag it to the left or right to adjust zooming ratio.

## 3.7 Display OSD Info

Go to **Settings**  $\rightarrow$  **Display Settings** to enable the information on-screen display.

### Status Icon

The device status icons, for example, battery status, memory card, hotspot, etc.

### Time and Date

Device time and date.

### Parameters

Temperature measurement parameters, for example, target emissivity, temperature unit, etc.

### Brand Logo

The brand logo is a manufacturer logo displayed on the upper right corner of the screen. You can turn it off if not needed.



## Chapter 4 Temperature Measurement

The thermography (temperature measurement) function provides the real-time temperature of the scene and display it on the left of your screen. The thermography function is turned on by default.

---

### Note

Your device will periodically perform a self-calibration to optimize image quality and measurement accuracy. In this process the image will pause briefly and you'll hear a "click" as a shutter moves in front of the detector. The self-calibration will be more frequent during start up or in very cold or hot environments. This is a normal part of operation to ensure optimum performance for your device.

---

### 4.1 Set Measurement Parameters

You can set measurement parameters to improve the accuracy of temperature measurement.

#### Steps

1. Go to **Settings** → **Measurement Settings** .
2. Set **Temperature Range**, **Emissivity**, etc.

#### **Temperature Range**

Select the temperature measurement range. The device can detect the temperature and switch temperature range automatically in **Auto Switch** mode.

#### **Emissivity**

Refer to [Common Material Emissivity Reference](#) to set the emissivity of your target.

#### **Reflection Temperature**

If any object (not the target) of high temperature is in the scene, and the target emissivity is low, set the reflection temperature as the high temperature to correct the temperature effect.

#### **Distance**

The distance between the target and the device. You can customize the target distance or select the target distance as **Near**, **Middle**, or **Far**.

#### **Humidity**

Set the relative humidity of current environment.

3. Return to previous menu to save the settings.

---

### Note

You can go to **Settings** → **Device Settings** → **Device Initialization** → **Remove All Measurement Tools** to initialize the temperature measurement parameters.

---

### 4.1.1 Set Unit



Go to **Settings** → **Device Settings** → **Unit** to set the temperature unit and distance unit.

### 4.2 Set Image Measurement

Device measures the temperature of the whole scene and can be manged to display the center, hot, and cold spot in the scene.

Press  to call the main menu and select  → . Select the desired spots to show their temperatures.

**Table 4-1 Icon Description**

Icon	Description
	Center spot of the scene (screen center). The temperature is displayed as <b>Cen XX</b> .
	Hot spot in the scene, which changes as the temperature or the scene changes. The temperature is displayed as <b>Max XX</b> .
	Cold spot in the scene, which changes as the temperature or the scene changes. The temperature is displayed as <b>Min XX</b> .



**Figure 4-1 Image Measurements**



## 4.3 Set Measurement Tool

You can set temperature measurement parameters to improve the accuracy of temperature measurement.

### Before You Start

Set parameters such as **Humidity** and **Reflection Temperature**. For detailed explanations, see [Set Measurement Parameters](#) .

### Steps

1. Press  to call the main menu.
2. Select  and press .
3. Select a type of temperature measurement tool

**Custom Spot** For configuring custom spot tools, see [Measure by Custom Spot](#) .

**Line** For the configuring line tools, see [Measure by Line](#) .

**Rectangle** For the configuring rectangle tools, see [Measure by Rectangle](#) .

**Circle** For the configuring circle tools, see [Measure by Circle](#) .

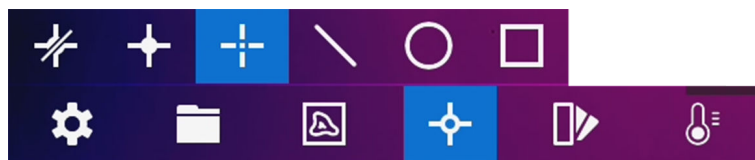

Figure 4-2 Temperature Measurement Tool



### What to do next

Set temperature alarm, then alarm actions such as audible warning and flashing alarm will be triggered when the tested temperature exceeds the set alarm value. See [Temperature Alarm](#) .

### 4.3.1 Measure by Custom Spot

The device can detect the temperature of a custom spot.

#### Steps

1. Select .
2. Press  to add a custom spot.
3. Move the spot with the navigation buttons, or tap on the touch-screen to select a spot and move it.
4. Tap  to modify temperature measurement parameters.

#### Emissivity

Refer to [Common Material Emissivity Reference](#) to set the emissivity of your target.

## Distance

Set the distance between the target and the device.

## Temp.

Tap to display or hide the temperature measurement result.

5. Press .



### Note

If the tool-specific emissivity and distance are set, the measurement is conducted based on the parameters. Otherwise, the parameters set from **Settings** → **Measurement Settings** are used for measurements.





---

The temperature of custom spot (e.g. P1) displays P1: XX.

6. Repeat the above steps to set other custom spots.



### Note

- At most ten custom spots are supported.
- Drag the spot tool list on the left of the screen, or press , , , and  to view the whole tool list.

7. **Optional:** Modify the set custom spot tools, hide or display the tools and measurement results, etc.



Tap to enter the editing interface and modify temperature measurement parameters such as emissivity and distance.



Tap to hide or display the tool and measurement results.



Tap to delete the tool.

8. Press  to save and exit.

## 4.3.2 Measure by Line

### Steps









1. Select .
2. Press  to generate a default line.



### Note

Only one line tool is supported.

---

3. Move the line to the required position.
  - Tap the line, and press , , , and  to move the line up/down/left/right.
  - Tap the line on touch-screen and drag it to the required position.
4. Adjust the length of the line.
  - Tap the end of the line, and press , ,  to extend or shorten the line.
  - Tap and drag the end of the line to extend or shorten it.
5. Tap  to modify temperature measurement parameters.

## Emissivity

Refer to **Common Material Emissivity Reference** to set the emissivity of your target.

## Distance

Set the distance between the target and the device.

## Max./Min./Average Temperature

Tap to enable the temperature types to display. The max. temperature, min. temperature, and average temperature of the line can be displayed on the left of the screen.

6. Press .



## Note

If the tool-specific emissivity and distance are set, the measurement is conducted based on the parameters. Otherwise, the parameters set from **Settings → Measurement Settings** are used for measurements.

7. Modify the set line tool, hide or display the tool and measurement results, etc.



Tap to enter the editing interface and modify temperature measurement parameters such as emissivity and distance.



Tap to hide or display the tool and measurement results.













Tap to delete the tool.

8. Press  to save and exit.

## 4.3.3 Measure by Rectangle

### Steps

1. Select .
2. Press  or tap  to generate a default rectangle.
3. Move the rectangle to the required position.
  - Tap the rectangle, and press , , , and  to move the rectangle up/down/left/right.
  - Tap and drag the rectangle on touch-screen to move it to the required position.
4. Adjust the size of the rectangle.
  - Tap one corner of the rectangle, and press , ,  to enlarge or contract the rectangle.
  - Tap and drag the corner of the rectangle on touch-screen to enlarge or contract it.
5. Tap  to modify temperature measurement parameters.

## Emissivity

Refer to **Common Material Emissivity Reference** to set the emissivity of your target.

## Distance

Set the distance between the target and the device.

## Max./Min./Average Temperature

Tap to enable the temperature types to display. The max. temperature, min. temperature, and average temperature of the rectangle area can be displayed on the left of the screen.

6. Press  to save the settings.

 **Note**

If the tool-specific emissivity and distance are set, the measurement is conducted based on the parameters. Otherwise, the parameters set from **Settings** → **Measurement Settings** are used for measurements.



7. Repeat the above steps to set other rectangle tools.

 **Note**

At most five rectangle tools are supported.

8. **Optional:** Modify the rectangle tools, hide or display the tools and measurement results, etc.

 Tap to enter the editing interface and modify temperature measurement parameters such as emissivity and distance.











 /  Tap to hide or display the tool and measurement results.

 Tap to delete the tool.

9. Press  to save and exit.

## 4.3.4 Measure by Circle

### Steps

1. Select .
2. Press  or tap  to generate a default circle.
3. Move the circle to the required position.
  - Tap the circle, and press , , , and  to move the circle up/down/left/right.
  - Tap and drag the circle on touch-screen to move it to the required position.
4. Adjust the size of the circle.
  - Tap one point on the circle, and press , ,  to enlarge or contract the circle.
  - Tap and drag one point of the circle on touch-screen to enlarge or contract it.
5. Tap  to modify temperature measurement parameters.

### Emissivity

Refer to **Common Material Emissivity Reference** to set the emissivity of your target.

### Distance

Set the distance between the target and the device.

### Max./Min./Average Temperature

Tap to enable the temperature types to display. The max. temperature, min. temperature, and average temperature of the circle area can be displayed on the left of the screen.

6. Press  to save the settings.

---

## Note

If the tool-specific emissivity and distance are set, the measurement is conducted based on the parameters. Otherwise, the parameters set from **Settings → Measurement Settings** are used for measurements.

---

7. Repeat the above steps to set other rectangle tools.
- 

## Note

At most five circle tools are supported.

---

8. **Optional:** Modify the circle tools, hide or display the tools and measurement results, etc.



Tap to enter the editing interface and modify temperature measurement parameters such as emissivity and distance.



Tap to hide or display the tool and measurement results.



Tap to delete the tool.

9. Press  to save and exit.

## 4.4 Temperature Alarm

When the temperature of targets triggers the set alarm, the device will perform configured actions, such as, flashing the rule frame, making an audible warning, or sending notification to the client software.

### 4.4.1 Set Alarms for Exceptional Temperatures

Alarm actions such as audible warning and flashing alarm are triggered when the tested temperature exceeds the set alarm value.

#### Steps

1. Go to **Settings → Measurement Settings → Alarm Settings** .
2. Tap to enable **Temperature Alarm**.
3. Set the alarm parameters.

#### Alarm Threshold

When the tested temperature exceeds the threshold, the device sends alarm notification to the client software. It beeps if the audible warning is enabled. The rectangle flashes red if the rectangle tool is configured.

#### Alarm Linkage

---

## Note

Supported alarm linkages vary on different models. See the actual device for available options.

---

- **Audible Warning:** The device beeps when target temperature exceeds the alarm threshold.
- **Flashing Alarm:** The flash light flashes when target temperature exceeds the alarm threshold.
- **Alarm Capture:** The device captures radiometric images when target temperature exceeds the alarm threshold.
- **Min. Alarm Interval:** It controls the minimal time interval between two alarm information uploading. It helps reduce repeated and frequent information receiving on the part of app and client software.

---

### Note

If you set rectangle and circle tools to measure temperature, the alarm threshold and linkage method settings only works in the measured areas. Otherwise, the parameters are valid for image temperature measurement (whole-screen temperature measurement).

---

## 4.5 Clear All Measurements

Tap  to clear all set temperature measurement tools.



## Chapter 5 Picture and Video

Insert memory card into the device, and then you can record videos, capture images, and mark and save important data.

---

### Note

- Device does not support capturing or recording when the menu is shown.
  - When the device is connected to your PC, it does not support capturing or recording.
  - Go to **Settings** → **Capture Settings** → **Filename Header** , you can set the filename header for capturing or recording to distinguish the files recorded in a specific scene.
  - Go to **Settings** → **Device Settings** → **Device Initialization** to initialize the memory card is needed.
- 

### 5.1 Capture Picture

Operate the device to capture live images and save the images in local albums.

#### Before You Start

Make sure that there is a working memory card mounted in your device. See [Appearance](#) to locate the memory card slot of your device.

#### Steps

1. Set a capture mode and pull **Trigger** in live view interface to capture images.

There are 3 modes available. Each mode requires different operations.

- 1) Go to **Settings** → **Capture Settings** → **Capture Mode** .
- 2) Select a mode.

#### Capture One Image

Pull **Trigger** once to capture one image.

#### Continuous Capture

Set the continuous capture amount after select this mode.

Pull **Trigger** in live view, and device captures the set amount of images continuously.

#### Scheduled Capture

Set the interval for scheduled capture after select this mode.

Pull **Trigger** in live view, and the device captures images according to the set interval. Pull **Trigger** again or press  to stop capturing.

- 3) Press  to return to the live view interface.

- 4) Aim the lens to your target and pull **Trigger** to capture images.

- Capture One Image: If **Edit before Saving** is NOT enabled ( **Settings** → **Capture Settings** ), the live image freezes and is saved in the default saving album. If **Edit before Saving** is enabled, the device enters the image editing interface.

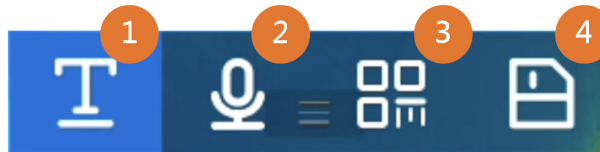

Figure 5-1 Editing Image Before Saving

Table 5-1 Editing Options

No.	Descriptions
1	Text Note Select text note and enter the editing page. Tap on screen to input content and press  to save.
2	Voice Note a. Select voice note and enter voice recording page. b. Press  or tap  to start recording. Press  or tap screen to stop recording. c. You can tap to play the recording. If the voice note is unsatisfactory, tap to delete it. Repeat above steps to record again. d. Press  to exit.
3	Scan QR Code a. Select QR code and the device enters the scanning mode. b. Aim the scanning frame at a QR code. Device reads the code and save the code information.
4	After all information added to the image, select <b>Save</b> to exit.

- Continuous Capture/Scheduled Capture: A counter displays in top of the screen showing the completed amount of capturing.

**2. Optional:** You can set more capture settings as demanded.

Table 5-2 More Optional Capture Settings

Objective	Settings
Save an additional visual image together with the thermal image.	Go to <b>Settings</b> → <b>Capture Settings</b> . Enable <b>Save Visual Image</b> and set <b>Visual Image Resolution</b> .
Set the naming rule for images.	The default image naming is filename header + saving time. Filename header is configurable. Saving time is the device system time when the saving occurs.

Objective	Settings
	Go to <b>Settings</b> → <b>Capture Settings</b> → <b>Filename Header</b> to set filename header.
View clear thermal image on high resolution screen.	Go to <b>Settings</b> → <b>Capture Settings</b> . Enable <b>SuperIR</b> before capturing. Resolution of captured images with <b>SuperIR</b> is about 4 times as the original one.

### What to do next

- Go to albums to view and manage files and album folders. See [Manage Albums](#) and [Manage Files](#) for operation instructions.
- To edit saved images, see [Edit Images](#) for operation instructions.
- You can connect your device to PC to export local files in albums for further use. See [Export Files](#) .

## 5.2 Record Video

### Before You Start

- A memory card should be mounted for video storage.
- Go to **Settings** → **Capture Settings** → **Flashlight** to enable flashlight in dark environment if you want to record an optical video.

### Steps

1. **Optional:** Go to **Settings** → **Capture Settings** → **Video Type** to set the video format.



#### Note

Video type configuration is supported by certain models of this series. MP4 video type is adopted for the models of no such configuration option.

---

### Radiometric Video

Radiometric data is attached in videos of this format. They can only be played and further analyzed with HIKMICRO Analyzer.





#### Note

- The frame rate of this format is 5 fps.
  - A video clip should be no longer than 10 minutes, and its size should be no larger than 4 GB.
  - When the storage space is smaller than 500 MB, radiometric video recording is not allowed. Accidentally stopped recordings are not saved.
- 

### MP4

Recorded videos are saved in .mp4 format. These video clips can be played on local device, and any player that support this format (HIKMICRO Analyzer does not support playing this video format.).



2. In the live view interface, hold the trigger to start recording.

The recording signs for radiometric video and MP4 videos are different. When you see , it is recording a MP4 video. When you see , it is recording a radiometric video.

3. When you finish, pull the trigger again to stop recording. The video will be saved automatically and exit.

---

### Note

You can also press  or  to stop recording.

---



### What to do next

Check the saved videos from  in menu mode. See [View and Manage Local Files](#) for more information.

## 5.3 View and Manage Local Files

Device captured images and videos are saved in local albums. You can create, delete, rename and set an album as the default saving album. For files, operations, such as browsing, moving and deleting, are available.

### Steps

1. Enter albums. In live view, press  to call the main menu, and select  to enter albums.
2. To create, rename, delete and set an album as the default saving album, see [Manage Albums](#) for instructions.
3. For file operations, such as, moving or deleting a file, see [Manage Files](#) for instructions.
4. To modify an image, for example, editing the text or voice notes saved with the images, and changing the thermal parameters, see [Edit Images](#) for instructions.

---

### Note

Image editing function varies within the series. See your actual device for available operation options.



---





5. Press  to exit.

### 5.3.1 Manage Albums

You can create several albums to manage captured images and video files on your device. Newly captured images and videos are saved in the **Default Saving Album** .

### Steps

1. Enter albums. In live view, press  to call the main menu, and select  to enter albums.







2. Create an album.
  - 1) Tap  in upper right corner to add an album.
  - 2) Edit the album name.
  - 3) Press  to save the album.
3. Rename, delete or set an album as the default saving album.
  - 1) Select an album and press .
  - 2) Tap  in upper right corner of the screen.
  - 3) Select **Set as Default Saving Album**, **Rename** or **Delete** as required.

The album icon turns to  when it is set as the default saving album.

## 5.3.2 Manage Files

Several formats of image video files are supported by the device. For certain format file, you can edit the attached notes and modify thermal parameters on device. For all files, you can check their basic information, delete or move them among albums.







### Steps

1. Enter albums. In live view, press  to call the main menu, and select  to enter albums.
2. Select an album and press .
3. Browse the image and video files.
  - 1) Select a file and press .
  - 2) Press  and  to browse the previous or the next file.
  - 3) Press  to call the operation menu to check more available operations. File formats and their supported operations are shown below.

**Table 5-3 File Formats and Operations**

File Type	Format	Descriptions
Radiometric Images	File Name.jpeg	Editing text and voice notes, moving files, checking basic information, modifying thermal parameters, and deleting files are supported on device. See <b><i>Edit Images</i></b> for instructions.
MP4 Videos	File Name.mp4	Playing, moving and deleting video files are supported on device.
Radiometric Video	File Name.rv	File of this format can not be played on your device. Use HIKMICRO Analyzer to play and analyze the files.  <div style="display: flex; align-items: center;">  <b>Note</b>                      This file type is not supported by certain models of this series.                 </div>

4. Moving or deleting several files.

- 1) In an album, tap  in the upper right corner of the screen.
- 2) Press  and  to select a file and press  . If you want to select all files, tap  in the upper right corner. If you want to cancel all selection, tap  .

A selected file displays with a  in its upper right corner.

- 3) Tap **Delete** or **Move**.

- If you tap delete, files are deleted after confirmation.
- If you tap move, select a target album to start moving.

### 5.3.3 Edit Images

Editing the text or voice notes saved with the images, and changing the thermal parameters are allowed on your thermal camera.

#### Note

Image editing function varies within the series. See your actual device for available operation options.

#### Steps









1. Enter albums. In live view, press  to call the main menu, and select  to enter albums.
2. Select an album and press  .
3. Select an image file and press  to call the editing menu.









Figure 5-2 Editing Image

4. Select an option and complete corresponding operations.

Table 5-4 Editing and Managing Images

No.	Description
1	Editing text note. Add a new text note or change the existed note, and press  to save the settings.
2	Editing voice note. You can add a new voice note, play or delete an existed voice note. <ul style="list-style-type: none"> <li>• If the file already has a voice note, tap to play or delete the note.</li> <li>• If the file has no voice note attached, press  or tap .</li> </ul>
3	Move the file to other albums. Select a target album and press  to confirm the moving.

No.	Description
4	Show basic information of the file, example the saving time, resolution of the file.
5	<p>Editing thermal parameters of the image.</p> <p>a. Press  or tap on the  to call the main menu.</p> <p>b. Modify the image display mode, measurement parameters and tools, palettes, and level &amp; span modes. For detailed operation instructions, see <b><i>Set Display Mode</i></b> , <b><i>Temperature Measurement</i></b> , <b><i>Set Palettes</i></b> , and <b><i>Adjust Display Temperature Range</i></b> .</p> <p>c. If you need a PDF report of the file, tap  on the upper right corner of the screen. Input <b>Report Name</b> and <b>Thermographer</b>, and tap  to generate the report.</p> <p> <b>Note</b></p> <p>Generated reports are saved under the same path of the memory card as the image files. The PDF reports can not be viewed on local device. Export and read reports on computers. See <b><i>Export Files</i></b> for instructions.</p> <p>d. When finishing all operations, tap  to save the change and exit the editing interface.</p>
6	Delete the file.

## 5.4 Export Files

Connect the device to your PC with supplied cable, you can export the recorded videos and captured snapshots.

---

### Note

Cast screen should be turned off before exporting files.

Go to **Settings** → **Connections** → **USB Cast Screen** or call the swipe-down menu to check the function status.

---

### Steps

1. Open the cover of cable interface.
  2. Connect the device to your PC with cable and open the detected disk.
  3. Select and copy the videos or snapshots to PC to view the files.
  4. Disconnect the device from your PC.
- 

### Note

For the first time connection, the driver will be installed automatically.

---

### **What to do next**

You can import the captured snapshots to HIKMICRO Analyzer for further data analysis. See the *User Manual of HIKMICRO Analyzer* (embedded in the client software, **Help → User Manual**) for the operation guide.



## Chapter 6 Thermal View Mobile Client Connection

The device supports both Wi-Fi connection and hotspot. Connect the device to HIKMICRO Viewer, and you can control the device via mobile client.

### 6.1 Connect via Wi-Fi

#### Before You Start

Download and install HIKMICRO Viewer on your phone.

#### Steps

1. Connect your device to a Wi-Fi network. See [Connect Device to Wi-Fi](#) for instructions.
2. Connect your phone to the Wi-Fi network that the device is in.
3. Launch the app and follow the startup wizard to create, and register an account.
4. Search and add the device to the mobile client.

#### Result

You can view the live view, capture snapshots, and record videos via the client.

### 6.2 Connect via Hot Spot

#### Before You Start

Download and install HIKMICRO Viewer on your phone.

#### Steps

1. Turn on the device hot spot and complete hot spot settings. See [Set Device Hotspot](#) for instructions.
2. Connect your phone to the Hotspot of the device.
3. Launch the app and follow the startup wizard to create, and register an account.
4. Search and add the device to the mobile client.

#### Result

You can view the live view, capture snapshots, and record videos via the client.

## Chapter 7 Connect Device to Wi-Fi

### Steps

1. Go to **Settings** → **Connections** → **WLAN** .
2. Tap  to enable Wi-Fi, and the searched Wi-Fi will be listed.

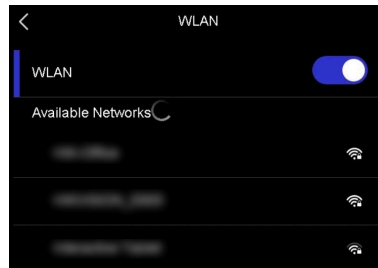

**Figure 7-1 Wi-Fi List**

3. Select Wi-Fi to connect to and a soft keyboard is displayed.
4. Enter the password.
5. Tap  to hide the keypad and connect Wi-Fi.

---

### **Note**

- DO NOT tap **space**, or the password may be incorrect.
  - Leaving the Wi-Fi setting interface does not interrupt the connection.
- 

### Result

A Wi-Fi icon shows on the main interface when the connection is completed.

### What to do next

You can turn off/on Wi-Fi connection from the swipe-down menu  .

## Chapter 8 Set Device Hotspot

With the device hotspot, other equipment with Wi-Fi function can join the device for data transmission.

### Steps

1. Go to **Settings** → **Connections** → **Hotspot** .
2. Tap  to enable hotspot function.
3. Tap **Set Hotspot**. A soft keyboard is displayed.

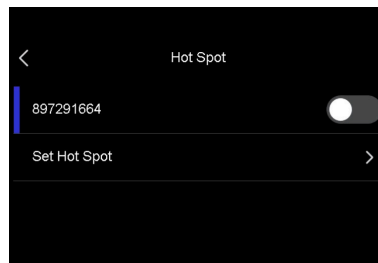

**Figure 8-1 Set Hotspot**

4. Set the password for the hotspot by touch the screen.

---

### **Note**

- When setting the password, do not tap **space**, or the password may be incorrect.
- The password should be at least 8 digits, consisting of numbers and characters.

5. Tap  to save.



### What to do next

You can turn off/on device hot spot from the swipe-down menu  .

## Chapter 9 Pair Bluetooth Devices

Pair your camera with an external bluetooth device to play the audio recorded together with the videos and the images.

### Steps

1. Select  from the main menu.
2. Go to **Settings** → **Connections** → **Bluetooth** .
3. Tap on  to enable the bluetooth.



### Note

Make sure the external bluetooth device is in discoverable mode.

---

The device searches and displays available nearby bluetooth devices.

4. Tap to select an external bluetooth device to start automatic pairing and connecting.

### What to do next

You can turn off/on bluetooth from the swipe-down menu  .

## Chapter 10 Cast Device Screen to PC

The device supports casting screen to PC by UVC protocol-based client software or player. You can connect the device to your PC via a type-C cable, and cast the real-time live view of the device to your PC.

### Steps



1. Go to **Settings** → **Connections** → **USB Cast Screen** to turn on the function on device. Or tap  in the swipe-down menu to turn on/off **USB Cast Screen**.
2. Open the UVC protocol-based client software on your PC.
3. Use a type-C cable to connect your device with PC.

### What to do next

For more instructions about how to cast the screen, please visit our website: <https://www.hikmicrotech.com/>

## Chapter 11 Light Settings

### 11.1 Set LED Light

Press  in live view to turn on/off the LED light. Or tap  in the swipe-down menu to quickly turn on/off LED light.

### 11.2 Set Laser

In the live view interface, hold  to enable/disable the laser light.



#### Caution

The laser radiation emitted from the device can cause eye injuries, burning of skin or inflammable substances. Before enabling the Light Supplement function, make sure no human or inflammable substances are in front of the laser lens.

---

## Chapter 12 Maintenance

### 12.1 View Device Information

Go to **Settings** → **Device Settings** → **Device Information** to view the device information.

### 12.2 Set Date and Time

#### Steps

1. Go to **Settings** → **Device Settings** → **Time and Date** .
2. Set the date and time.
3. Press  to save and exit.



Go to **Settings** → **Display Settings** to enable time and date on-screen display.

---

### 12.3 Upgrade Device

#### Before You Start

Please download the upgrade file from the official website <http://www.hikmicrotech.com> or contact the custom service and technical support to get the upgrade file first.

#### Steps

1. Connect the device to your PC with a type-C cable and open the detected disk.
2. Copy the upgrade file and paste it to the root directory of the device.
3. Disconnect the device from your PC.
4. Reboot the device and then it will upgrade automatically. The upgrading process will be displayed in the main interface.



After upgrading, the device reboots automatically. You can view the current version in **Settings** → **Device Settings** → **Device Information** .

---

### 12.4 Restore Device

Go to **Settings** → **Device Settings** → **Device Initialization** to initialize the device and restore default settings.

## 12.5 Initialize Memory Card

When a memory card is use on the handheld thermal camera for the first time, it needs to be initialized first.

Go to **Settings** → **Device Settings** → **Device Initialization** to initialize the memory card.

---



### **Caution**

If there are files in the memory card, make sure that the files has been backed up before memory card initialization. Once the card is initialized, data and files can not be recovered.

---

## 12.6 About Calibration

We recommend you send the device back for calibration once a year, and please contact the local dealer for the information on maintenance points. For more detailed calibration services, please refer to <https://www.hikmicrotech.com/en/support/calibration-service/>.



## Chapter 13 Appendix

### 13.1 Common Material Emissivity Reference

Material	Emissivity
Human Skin	0.98
Printed Circuit Board	0.91
Concrete	0.95
Ceramic	0.92
Rubber	0.95
Paint	0.93
Wood	0.85
Pitch	0.96
Brick	0.95
Sand	0.90
Soil	0.92
Cloth	0.98
Hard Paperboard	0.90
White Paper	0.90
Water	0.96

### 13.2 FAQ

Scan the following QR code to get device common FAQ.



## 13.3 Device Command

Scan the following QR code to get device common serial port commands.

Note that the command list contains the commonly used serial port commands for HIKMICRO thermal cameras.



## 13.4 Device Communication Matrix

Scan the following QR code to get device communication matrix.

Note that the matrix contains all communication ports of HIKMICRO thermal cameras.





**HIKMICRO**

See the World in a New Way

Facebook: HIKMICRO Thermography  
Instagram: hikmicro\_thermography  
E-mail: support@hikmicrotech.com  
Website: www.hikmicrotech.com

LinkedIn: HIKMICRO  
YouTube: HIKMICRO Thermography

UD32375B